

Read and fully understand ALL instructions before beginning.

- 1 Use safe lifting techniques.
- 2 Although EZ-Door Frames are not fragile, to ensure proper mounting, they should always be handled with care to avoid bending.
- 3 Do not subject the EZ-Door Frames to extremes of heat. Buildings where temperature is controlled provide the best conditions (recommended conditions 33°F to 100°F).
- 4 In order to prevent door use during installation, it is recommended you notify others of your intended work.
- 5 Do not install EZ-Door Frames on doors that have surface moisture or dirt.
- 6 Choking Hazard—Small Parts. Not for children.

Warranty & Parts Replacement Information

The item must be returned in good condition, in original boxes (whenever possible), and with all paperwork, parts and accessories to ensure full credit.

What This Warranty Covers: Trevconn Enterprises warrants its parts and products to be free of substantial defects in materials and workmanship from the original date of purchase under normal home use. This warranty is offered only to the original consumer purchaser and may not be transferred.

How Long The Warranty Lasts: Coverage lasts for one year from the original date of purchase.

What Trevconn Enterprises Will Do Under The Warranty: During the warranty period Trevconn Enterprises will replace any part or product that proves to have substantial defects in materials or workmanship.

Implied Warranties: Trevconn Enterprises disclaims any implied warranty of merchantability, and there are no warranties that extend beyond the descriptions on the face hereof. To the extent that such disclaimer is not valid under applicable law, any implied warranty shall be coextensive in duration with this warranty.

What This Warranty Does Not Cover: This warranty does not cover any problems or damage which result from improper transportation, improper installation including sealant or paint products, mishandling, misuse, abuse, neglect, abnormal use, improper maintenance, accidents, or acts of God, such as hurricanes, fire, earthquakes or floods. This warranty and any applicable implied warranties do not cover incidental or consequential damages arising from any defects in the product, such as labor charges for installation or removal of the product or any associated products. This warranty does not cover defects or damage caused by normal wear & tear, alterations, environmental conditions, or mold.

Question, problems, missing parts? Before returning to the store,

Call Trevconn Enterprises Customer Service

8 a.m.—5 p.m., PST, Monday—Friday

1-805-754-2371

WWW.TREVCNN.COM

ONLINE INSTALLATION VIDEO: WWW.TREVCNN.COM

THANK YOU

We appreciate the trust and confidence you have placed in Trevconn Enterprises through the purchase of EZ-Door Self Adhering Door Frames. We strive to continually create quality products designed to enhance your home. Thank you for choosing Trevconn Enterprises.

Warranty & Parts Replacement Information (Continued)

How to Obtain Warranty Service: If you need replacement parts or would like to make a warranty claim, please contact our Customer Service Representative by mail, email, fax or telephone at the address or phone numbers listed on this page. All warranty claims must include the model number of the product, copy of the original receipt and the nature of the problem. In addition, Trevconn Enterprises may at its discretion authorize the prepaid return of the claimed defective part. Merchandise not pre-approved for return will not be accepted and the associated claim not accepted.

Products should be examined for defects prior to installation. This warranty also does not cover labor charges for installation or removal of the product or any associated products. If upon inspection you find our product has a damaged or missing part, please contact Trevconn Enterprises customer service to obtain a replacement part.

Warranty Contact Information:

Email: warranty@trevconn.com
Telephone: (805) 754-2371
Fax: (805) 754-3738
Mail: Trevconn Enterprises
1597 Corte Del Rey
Thousand Oaks, CA 91360

Pre-Installation

Read Installation Guide & Watch Online Video: Trevconn Enterprises recommends you read this entire installation guide prior to beginning the installation. Watch the online video: www.trevconn.com/videos

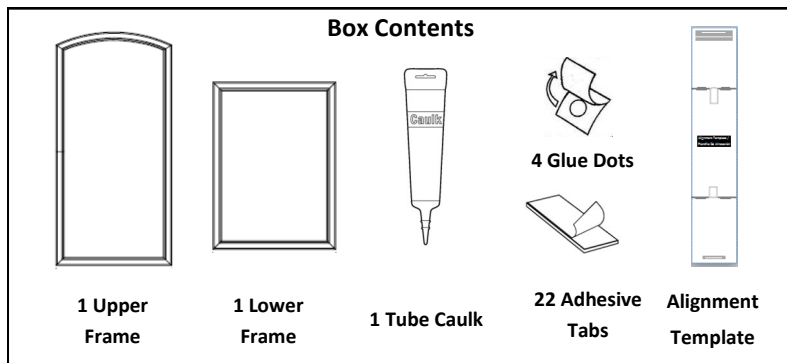

ONLINE INSTALLATION VIDEO: WWW.TREVCONN.COM

Installation Steps 1—9

STEP 1

Remove the EZ-Door Frames and verify all of the box contents are included. Wipe the door surface clean if needed.

STEP 2

Remove one side of the paper backing from the double sided adhesive tabs and firmly affix the tabs to the back side of the lower and upper frames in the areas shown in the illustration below. The tabs must be adhered to the flat surface on the back side of the frames which are the approximate size of the tab. Set both frames aside backside up. (Note: There are 20 tab adhesion points, 2 extra tabs are provided for your convenience.)

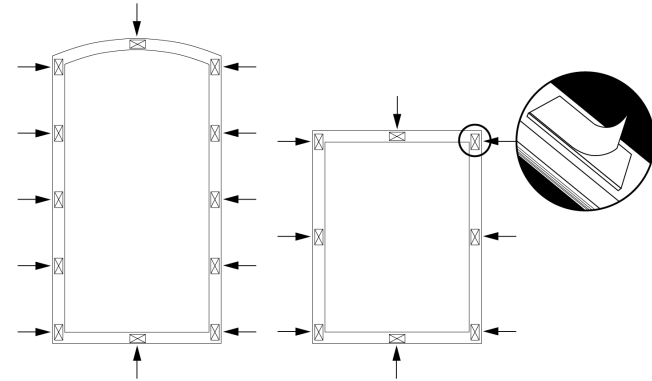

STEP 3

Locate four glue dots, tear at perforation and peel tabs apart. Place one glue dot in each of the positions A, B, C and D on the reverse side of Alignment Template with the adhesive on paper surface, press firmly to apply. Once applied discard remaining paper tabs. The template is now ready to adhere to the door surface for aligning EZ-Door. Proceed to Step 4 on page 5



Glue Dots

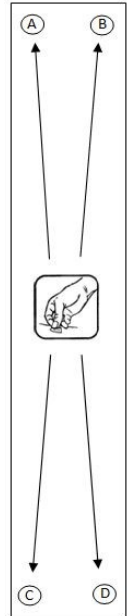

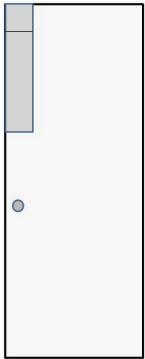
LEFT HANDLE**STEP 4****RIGHT HANDLE**

Align the alignment template's upper left (if door handle on left) or right (if door handle on right) hand corner paper edges with the upper left or right hand corner of the door edges and with the left or right hand door edge as shown in the illustrations to the left and right. Press firmly in the upper and lower areas of the template where the glue dots are located to apply the template.

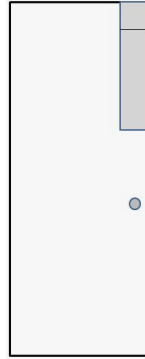
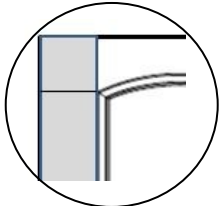
**STEP 5**

Carefully align the upper frame with the upper frame alignment lines on the template as shown in the illustrations to the left or right depending on the door handle location. Press firmly in the areas where the adhesive tabs are located on the upper frame as placed in Step 2.

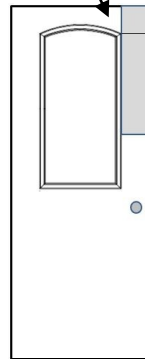
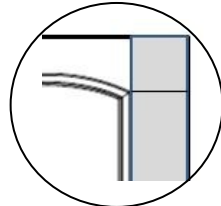
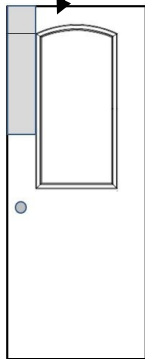
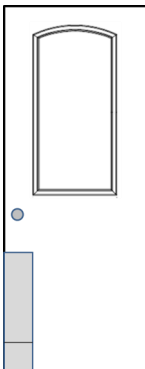
**STEP 6**

Remove the alignment template from the top of the door. Align the lower left (if door handle on left) or right (if door handle on right) hand corner paper edges with the lower left or right hand corner of the door edges as shown in the illustrations to the left and right. Press firmly in the upper and lower areas of the template where the glue dots are located to reapply the template.

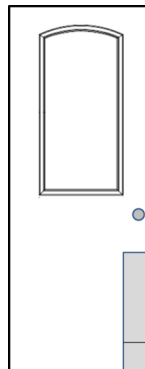
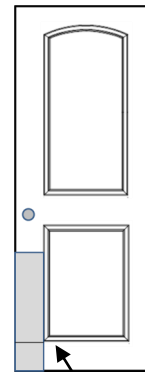
**LEFT HANDLE****STEP 7****RIGHT HANDLE**

Carefully align the lower frame with the lower frame alignment lines on the template as shown in the illustrations to the left or right depending on the door handle location. Press firmly in the areas where the lower frame adhesive tabs are located as placed in Step 2.

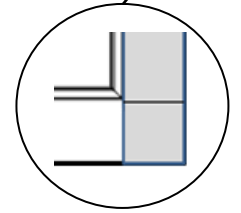
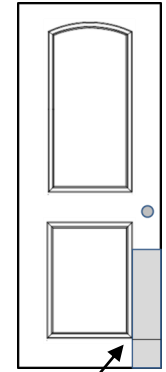
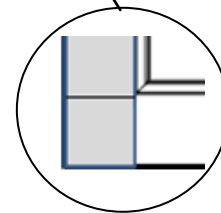
**STEP 8**

Using the caulk provided completely caulk the inside and outside edges of the frames where they meet the door surface. **(Hint: Use the caulk sparingly and smooth to a neat appearance.)** Let caulk cure prior to painting the door.

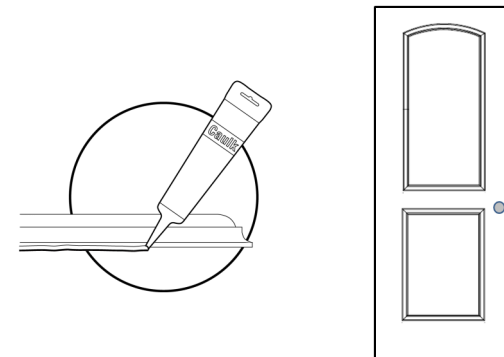
**STEP 9**

Clean surface of door if needed. Paint the desired color using a latex based paint. **(Note: Not all oil base paints will adhere to EZ-Door's Frames. Check with your paint vendor for compatibility)** Enjoy your new modern looking door.